

ab 05/2021

399459262		Spültisch-Einhandmischer Multi DN 15	single lever sink mixer multi DN 15
1	7488436-00	HEBEL MX	LEVER MX
1.1	92204601-00	GEWINDESTIFT	GRUB SCREW
1.2	93089705B-00	STOPFEN	PLUG
2	7403036-00	KÜCHENBRAUSE	KITCHEN SHOWER
2.1	7470105-00	STRAHLREGLER	AERATOR
3	93088605-00	ABDECKKAPPE	COVER CAP
4	93065100-00	SPANNSCHRAUBE	FASTENING SCREW
5	7685600-00	STEUEREINHEIT	CERAMIC CARTRIDGE
6	7463336-00	BRAUSEHALTER	SHOWER HOLDER
7	7812200-00	DICHTUNGSSATZ	SEALING SET
8	7563600-00	BEFESTIGUNGSSATZ	MOUNTING KIT
9	93001600-00	VERSTÄRKUNGSPLATTE	STABILIZER PLATE
10	7654000-00	KÜCHENSCHLAUCH	KITCHEN HOSE
11	7510600-00	RÜCKFLUSSVERHINDERER	BACK FLOW PREVENTER
12	7386900-00	SCHNELLKUPPLUNG	QUICK CONNECT
13	7520900-00	BLEIGEWICHT	LEAD WEIGHT
14	7522100-00	ANSCHLUSSNIPPEL	CONNECTING NIPPLE
15	7409736-00	ADAPTER MULTI	ADAPTER MULTI
16	7522200-00	KERAMIK - OBERTEIL	CERAMIC HEAD PART
17	7487836-00	GRIFF	HANDLE
17.1	92204601-00	GEWINDESTIFT	GRUB SCREW
99	92912800-00	SPANNSCHRAUBENSCHLÜSSEL	WRENCH FOR FASTENING SCREW

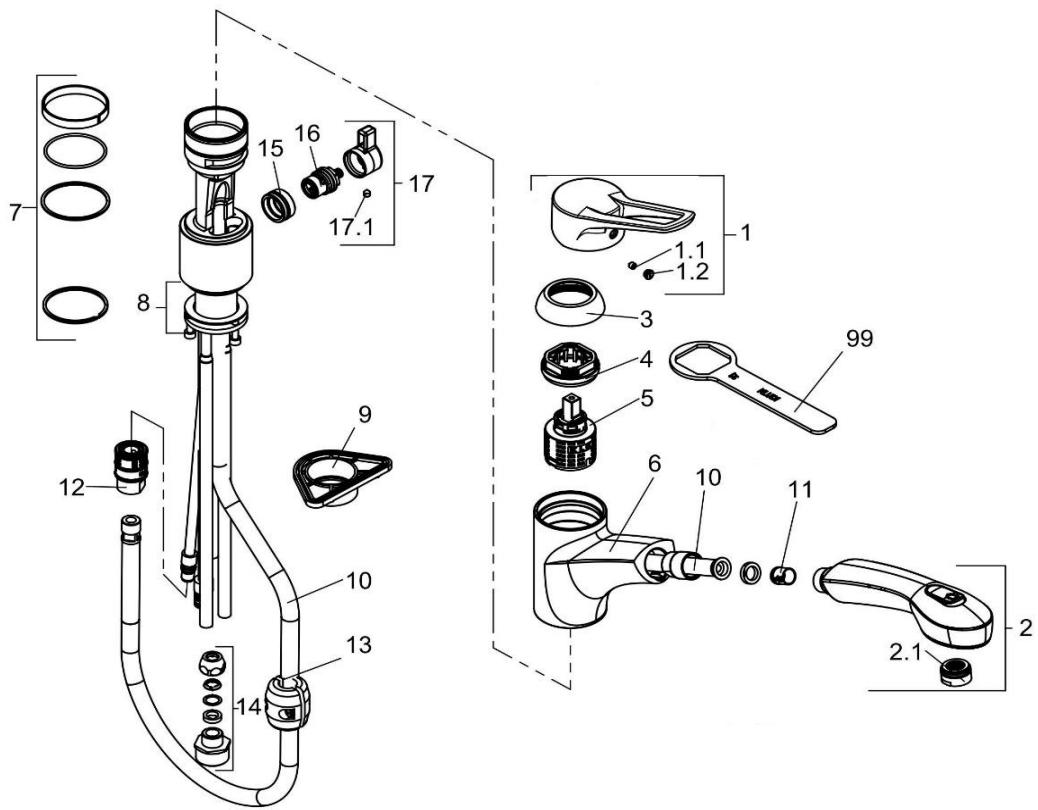

bis 04/2021

399459262		Spültisch-Einhandmischer Multi DN 15	single lever sink mixer multi DN 15
1	7488436-00	HEBEL MX	LEVER MX
1.1	92204601-00	GEWINDESTIFT	GRUB SCREW
1.2	93089705B-00	STOPFEN	PLUG
2	7403036-00	KÜCHENBRAUSE	KITCHEN SHOWER
2.1	7470105-00	STRAHLREGLER	AERATOR
3	93088605-00	ABDECKKAPPE	COVER CAP
4	93065100-00	SPANNSCHRAUBE	FASTENING SCREW
5	7685600-00	STEUEREINHEIT	CERAMIC CARTRIDGE
6	7463336-00	BRAUSEHALTER	SHOWER HOLDER
7	7812200-00	DICHTUNGSSATZ	SEALING SET
8	7563600-00	BEFESTIGUNGSSATZ	MOUNTING KIT
9	93001600-00	VERSTÄRKUNGSPLATTE	STABILIZER PLATE
10	7654000-00	KÜCHENSCHLAUCH	KITCHEN HOSE
11	7510600-00	RÜCKFLUSSVERHINDERER	BACK FLOW PREVENTER
12	7325000-00	SCHNELLKUPPLUNG / nicht lieferbar	QUICK CONNECT / not available
13	7520900-00	BLEIGEWICHT	LEAD WEIGHT
14	7522100-00	ANSCHLUSSNIPPEL	CONNECTING NIPPLE
15	7409736-00	ADAPTER MULTI	ADAPTER MULTI
16	7522200-00	KERAMIK - OBERTEIL	CERAMIC HEAD PART
17	7487836-00	GRIFF	HANDLE
17.1	92204601-00	GEWINDESTIFT	GRUB SCREW
99	92912800-00	SPANNSCHRAUBENSCHLÜSSEL	WRENCH FOR FASTENING SCREW

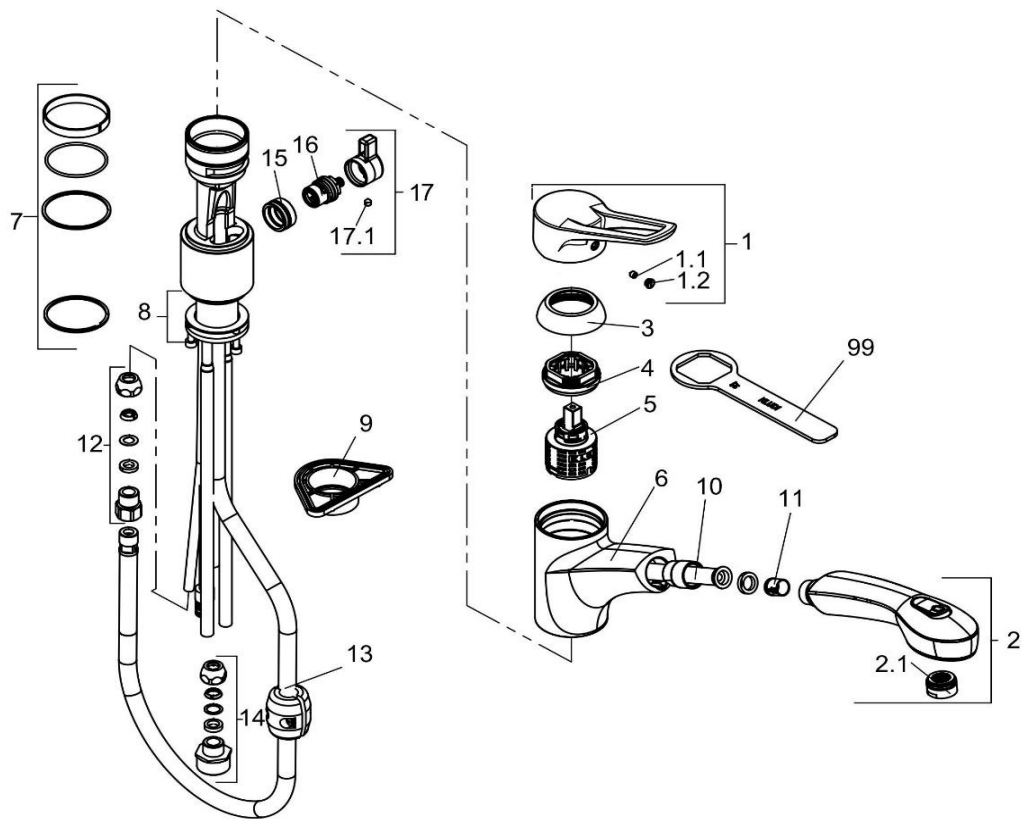

bis 11/2015

399459262		Spültisch-Einhandmischer Multi DN 15	single lever sink mixer multi DN 15
1	7488436-00	HEBEL MX	LEVER MX
1.1	92204601-00	GEWINDESTIFT	GRUB SCREW
1.2	93089705B-00	STOPFEN	PLUG
2	7403036-00	KÜCHENBRAUSE	KITCHEN SHOWER
2.1	7470105-00	STRAHLREGLER	AERATOR
3	93088605-00	ABDECKKAPPE	COVER CAP
4	93065100-00	SPANNSCHRAUBE	FASTENING SCREW
5	7685600-00	STEUEREINHEIT	CERAMIC CARTRIDGE
6	7463336-00	BRAUSEHALTER	SHOWER HOLDER
7	7812200-00	DICHTUNGSSATZ	SEALING SET
8	7563600-00	BEFESTIGUNGSSATZ	MOUNTING KIT
9	93001600-00	VERSTÄRKUNGSPLATTE	STABILIZER PLATE
10	7654000-00	KÜCHENSCHLAUCH	KITCHEN HOSE
11	7510600-00	RÜCKFLUSSVERHINDERER	BACK FLOW PREVENTER
12	7676100-00	QUETSCHVERSCHRAUBUNG	COMPRESSION JOINT
13	7520900-00	BLEIGEWICHT	LEAD WEIGHT
14	7522100-00	ANSCHLUSSNIPPEL	CONNECTING NIPPLE
15	7409736-00	ADAPTER MULTI	ADAPTER MULTI
16	7522200-00	KERAMIK - OBERTEIL	CERAMIC HEAD PART
17	7487836-00	GRIFF	HANDLE
17.1	92204601-00	GEWINDESTIFT	GRUB SCREW
99	92912800-00	SPANNSCHRAUBENSCHLÜSSEL	WRENCH FOR FASTENING SCREW